

BATHROOM
ACCESSORIES





HANGFAT was established in Jiangmen, China, 1994. It is a classic Chinese metal product brand with a history of 30 years.

We set product development, manufacturing and independent marketing in one, and always insist that the details are king. That is how we were born, grew and become powerful.

HANGFAT provide OEM/ODM service for our customers. Adequate machines and production lines can achieve a monthly production capacity of 800,000 pairs/set. Our product lines cover stainless steel handles, turn knobs, back plates, locksets, hinges and so on.

In the past years, HANGFAT stuck to the strict raw material inspection & acceptance standards and material distribution system. We continue to innovate production processes to reduce production spoilage, achieving better cost and quality control.

HANGFAT believes important people need more professional protection. All the important objects of protection can be "Safe, always around"!

"PIONEER ROLE" -focus, professional, leading!

OUR TEAM

Core belief: Through expertise and love, for more space to achieve hand-in-hand security system.

Mission: Important people, need more professional guarding.

Vision: "Pioneer role"-Focus, Professional, Leading.

Value: All important objects of protection can be "Safe, always around".



江门恒發金屬

 **HANGFAT**
METAL

Take Safety with You

把握安全，常伴左右

**TAKE SAFETY
WITH YOU**

DETAILS ARE KING

HANGFAT was established in Jiangmen, China, 1994.
It is an classic Chinese metal product brand with a
history of 30 years.

We set product development, manufacturing and
independent marketing in one, and always insist that
the details are king.

That is how we were born, grew and become powerful.

AUTOMATION MORE PROFESSIONAL

HANGFAT has technicians with decades of industry experience
Their production precision is close to the machine.
But for this "close",
We insist on introducing dozens of new & advanced machines.

3D automatic welding machine is highly efficient and accurate, ensuring uniform, stable and beautiful appearance of each solder joint;
Automatic polishing machine for every detail of the product has a delicate, smooth texture, and shiny;
Laser marking machine, high-speed, exquisite lines, to ensure the quality of our products and production capacity;

.....

We are always dedicated to speciality and meticulousness, perfecting every detail and making every product reliable.



QUALITY IS MARKET

HANGFAT provide OEM/ODM service for our customers. Adequate machines and production lines can achieve a monthly production capacity of 800,000 pairs/set. Our product line covers stainless steel handles, turnknobs, back plates, locksets, hinges and so on.

In the past 30 years, HANGFAT stuck to the strict raw material inspection & acceptance standards and material distribution system. We follow the principle of first-in, first-out in inventory control. 12 quality inspection processes ensure that each product undergoes rigorous testing before it can be distributed on the market.





INNOVATION LEADS FUTURE

HANGFAT continues to innovate production processes to reduce production spoilage, thereby achieving better cost and quality control. At the same time, we are constantly optimizing product design, focusing on the fit of technology and life, and presenting the natural beauty with texture.

Each of HANGFAT's products is comfortable, safe and beautiful, meeting the needs of modern life and suitable for a variety of modern home styles.

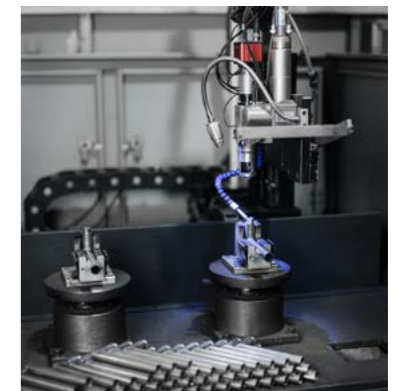
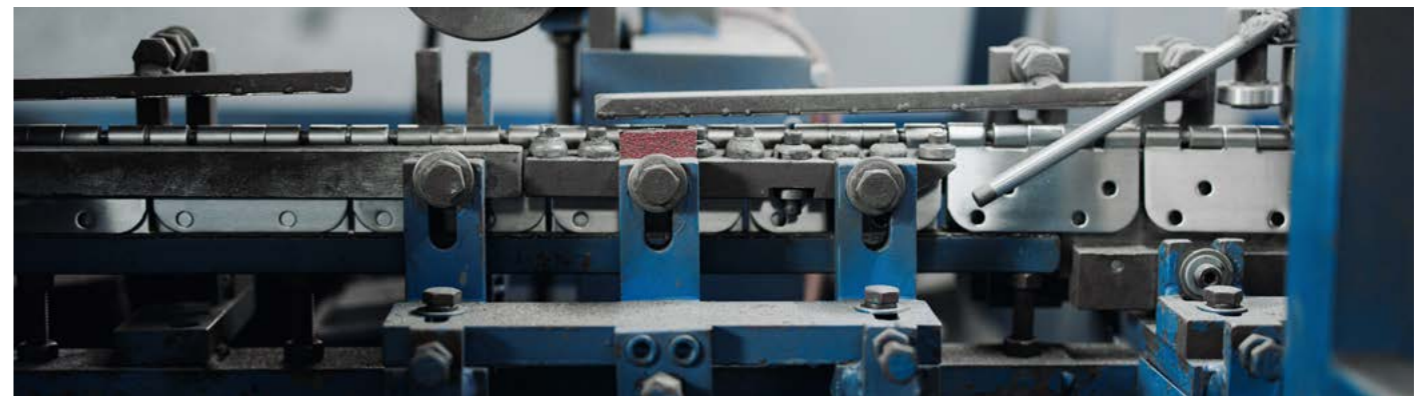

HANGFAT CERTIFICATIONS



Certificate of Environmental Management System



Certificate of Quality Management System



Pollutant Emission Permit



CE Certificate

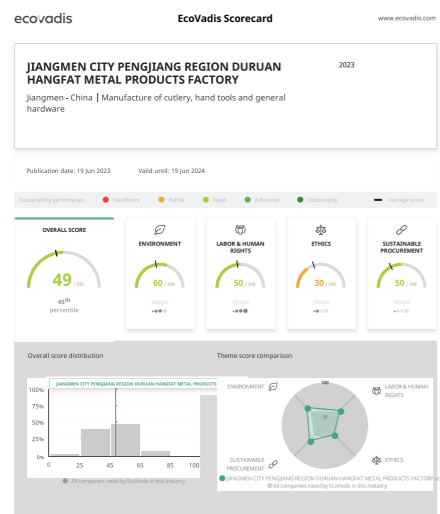

ESG Certificate



Work Safety Standardization Certificate (Level 3)



RoHS Certificate

Intertek TEST REPORT
Performance test

Report Reference No.: G271212284
Tested by (name and signature): Alan Lai
Approved by (name and signature): Bikang Dong
Date of Issue: January 23, 2013
Contents: Total test report 9 pages including Report text: 3 pages Appendix A for product photos: 2 pages

Testing Laboratory name: Intertek Testing Services (Shenzhen) Ltd. Guangdong Branch
Address: Block E, No.7-2 Huang Dong Software Science Park, Cixin Road, Guangzhou Science City, GUTD, Guangzhou, China
Testing location: Same as above
Applicant's name: JIANGMEN CITY PENGJIANG REGION DURUAN HANGFAT METAL PRODUCTS FACTORY
Address: NANCHANG INDUSTRIAL DISTRICT, DURUAN TOWN, JIANGMEN CITY, GUANGDONG PROV., CHINA (529075)

Test specification:
Standard: EN 1670:2007AC:2009
Non-standard test method: S2524
Test item description: SUS304 Stainless steel 2 ball bearing ball hinge
Trade Mark: /
Model and/or type reference: E'X3 E'X3.0mm
Manufacturer: JIANGMEN CITY PENGJIANG REGION DURUAN HANGFAT METAL PRODUCTS FACTORY
Rating(s): Grade 4 (340 hours) Corrosion Resistance (neutral salt spray)

CONCLUSION
The submitted samples were tested and **COMPLIED WITH** Grade 4 Corrosion Resistance of EN 1670:2007AC:2009

Intertek Testing Services (Shenzhen) Ltd. Guangdong Branch
Block E, No.7-2 Huang Dong Software Science Park, Cixin Road, Guangzhou Science City, GUTD, Guangzhou, China
Tel: 86 020 67199881 Fax: 86 020 67199880

EN1670 Performance Test Report

HANGFAT CERTIFICATIONS



EN1906 Grade 3 Certificate



EN1906 Grade 4 Certificate



EN1906 Grade 4 Certificate



EN1935 Grade 14 Certificate



Utility Model Patent



Utility Model Patent



Utility Model Patent



Utility Model Patent



Utility Model Patent



Utility Model Patent



Appearance Design Patent



Appearance Design Patent

Door direction

The door direction(left/right)according to DIN 107 is determined as follows:

Visible position of the door hinges on the left: **(Din)left**

Visible position of the door hinges on the right: **(Din)right**

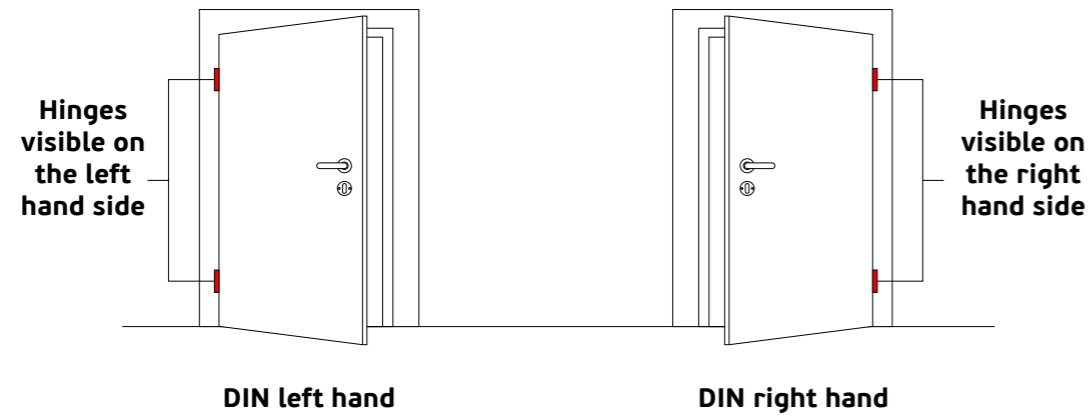

Door opening direction

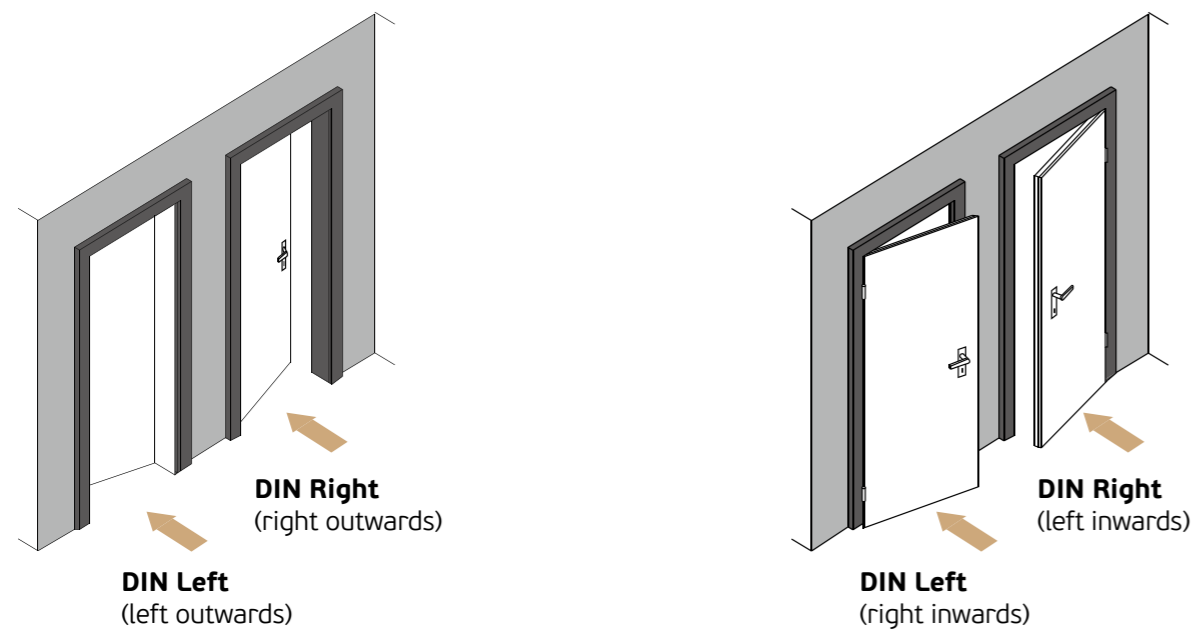

Lever handle direction

Lever handle aperture part pointing to the left

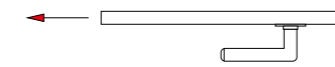

Version "left hand"

Lever handle aperture part pointing to the right

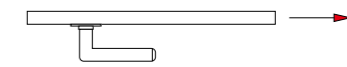

Version "right hand"

When selecting alternate sets with asymmetrical handles a distinction to the right/left is required. It is therefore necessary to observe the particular door direction.

Examples of asymmetric lever handles

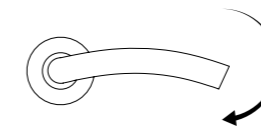

Examples of symmetrical lever handles

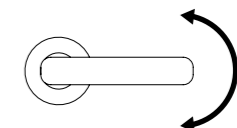



SSS-Satin



PSS-Polished



PVDSG-PVD Satin Gold



PVDPG-PVD Polished Gold



PVDSM-PVD Matt Black



CRS-PVD Satin Chrome



PVDSK-PVD Satin Copper



CRP-PVD Polished Chrome

FINISH TREATMENT

HANGFAT's factory finish paint offers a variety of popular standard color choices along with custom match options. The finish paint is applied to our quality commercial products, carefully packaged and supplied to our customer, pre-finished. Our efficient method of application and pre-finished delivery saves in money and time - from a brand you know and trust.

ACCESSORIES COMMON SIZE

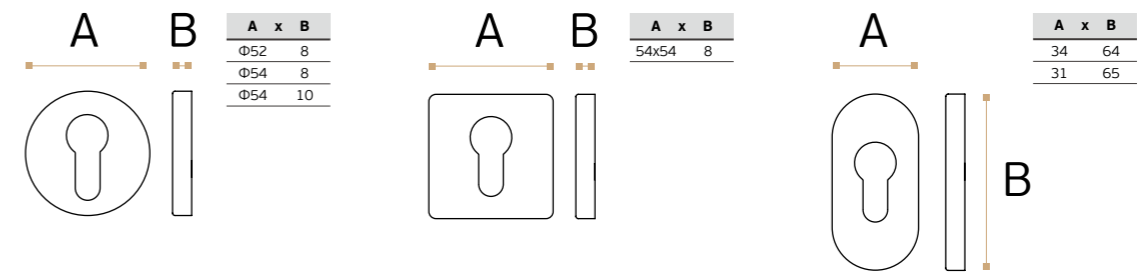
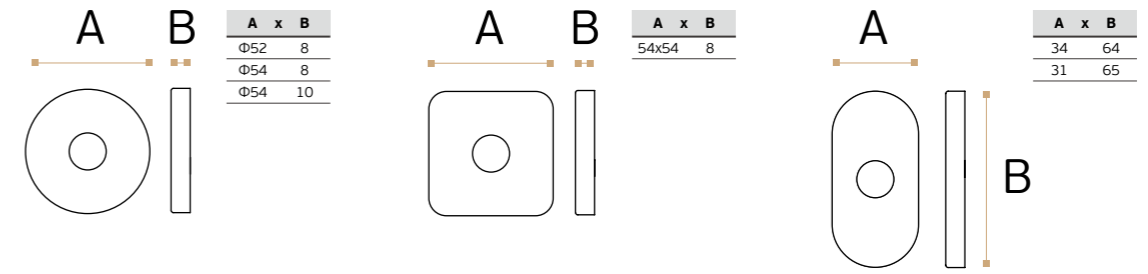

ICON DEFINITION

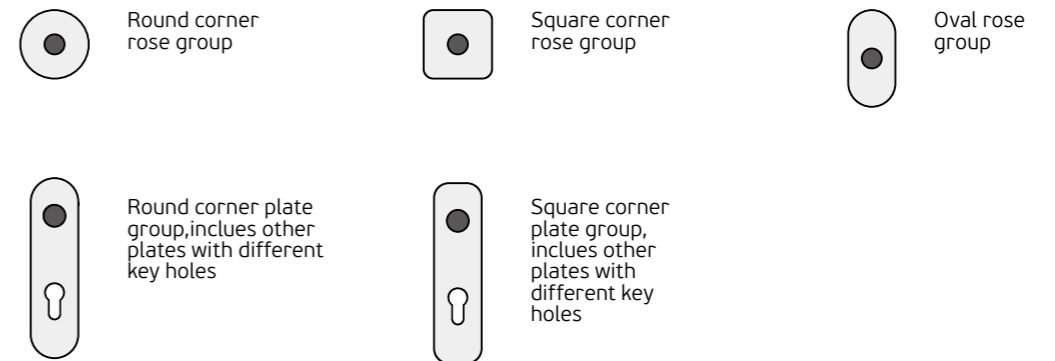

BATHROOM ACCESSORIES



FINISH TREATMENT

HANGFAT's factory finish paint offers a variety of popular standard color choices along with custom match options. The finish paint is applied to our quality commercial products, carefully packaged and supplied to our customer, pre-finished. Our efficient method of application and pre-finished delivery saves in money and time - from a brand you know and trust.



Brushed gun metal



Brushed nickel



Matt black



PSS-Polished



PVD-SG



SSS

BATHROOM ACCESSORIES / TOWEL SHELF

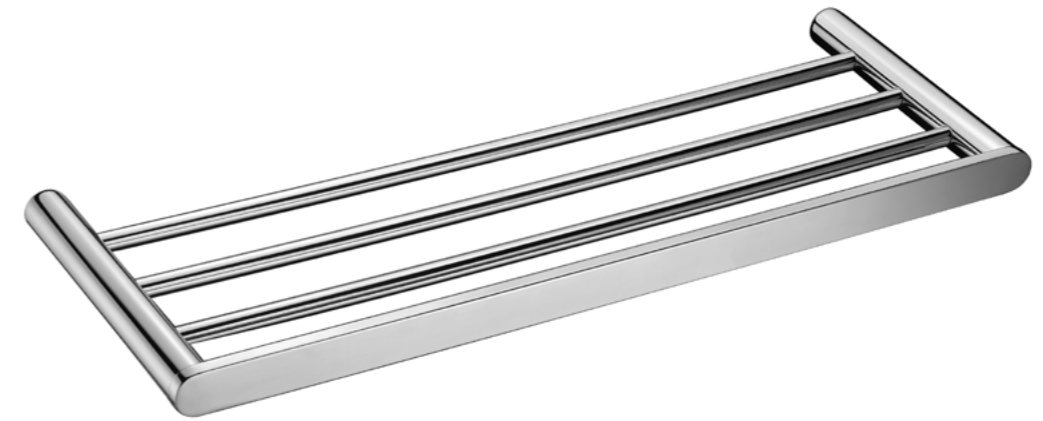

BA82702

Material:SUS304
Type: Towel shelf
Available Finishes:
SSS/ PSS/ PVD-SG/ Matt Black/Brushed Nicekl/
Brushed gun metal

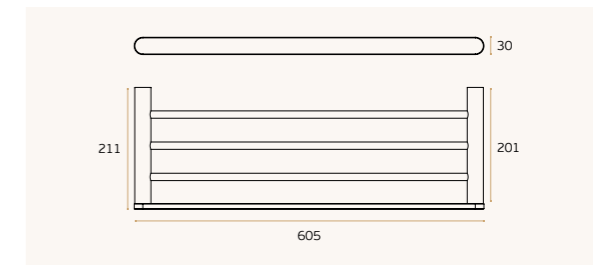

BATHROOM ACCESSORIES / TOWEL RAIL



BA82703

Material:SUS304
Type: Towel rail
Available Finishes:
SSS/ PSS/ PVD-SG/ Matt Black/Brushed Nicekl/
Brushed gun metal

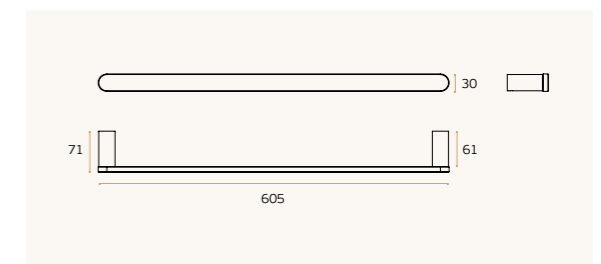

**BA82704**

Material:SUS304
Type: Towel rail
Available Finishes:
 SSS/ PSS/ PVD-SG/ Matt Black/Brushed Nickel/
 Brushed gun metal

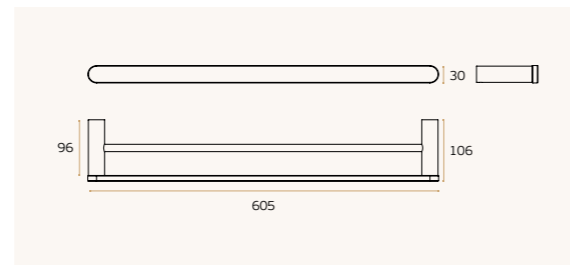
**BATHROOM ACCESSORIES /
SOAP DISH****BA82705**

Material:SUS304
Type: Soap dish
Available Finishes:
 SSS/ PSS/ PVD-SG/ Matt Black/Brushed Nickel/
 Brushed gun metal

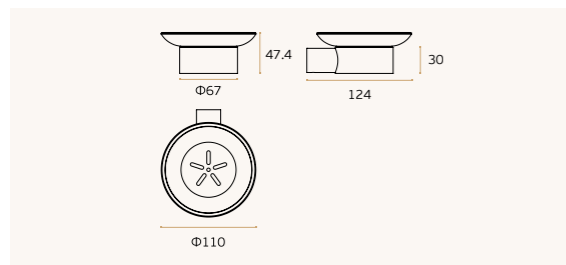
**BA82705A**

Material:SUS304
Type: Soap dish
Available Finishes:
 SSS/ PSS/ PVD-SG/ Matt Black/Brushed Nickel/
 Brushed gun metal

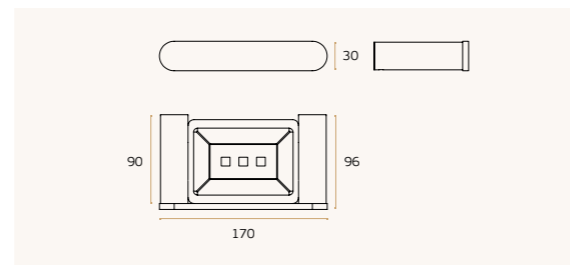
**BATHROOM ACCESSORIES /
GLASS HOLDER****BA82706**

Material:SUS304
Type: Glass holder
Available Finishes:
 SSS/ PSS/ PVD-SG/ Matt Black/
 Brushed Nickel/Brushed gun metal

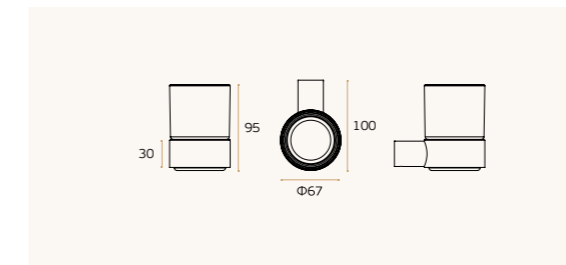
**BATHROOM ACCESSORIES /
PAPER HOLDER****BA82707**

Material:SUS304
Type: Paper holder
Available Finishes:
 SSS/ PSS/ PVD-SG/ Matt Black/Brushed Nickel/
 Brushed gun metal

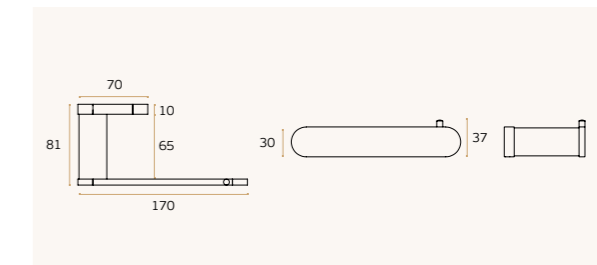
**BATHROOM ACCESSORIES /
TOWEL RAIL****BA82708**

Material:SUS304
Type: Towel rail
Available Finishes:
 SSS/ PSS/ PVD-SG/ Matt Black/Brushed Nickel/
 Brushed gun metal

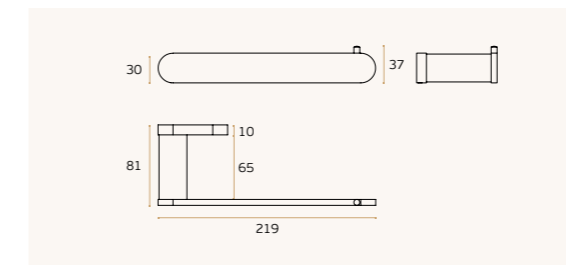
**BATHROOM ACCESSORIES /
HOOK****BA82709-B**

Material:SUS304
Type: Hook
Available Finishes:
 SSS/ PSS/ PVD-SG/ Matt Black/Brushed Nickel/
 Brushed gun metal

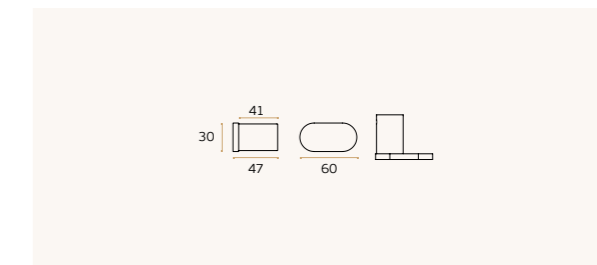

BATHROOM ACCESSORIES / TOILET BRUSH HOLDER



BA82711

Material:SUS304

Type: Toilet brush holder

Available Finishes:
SSS/ PSS/ PVD-SG/ Matt Black/Brushed Nicekl/
Brushed gun metal

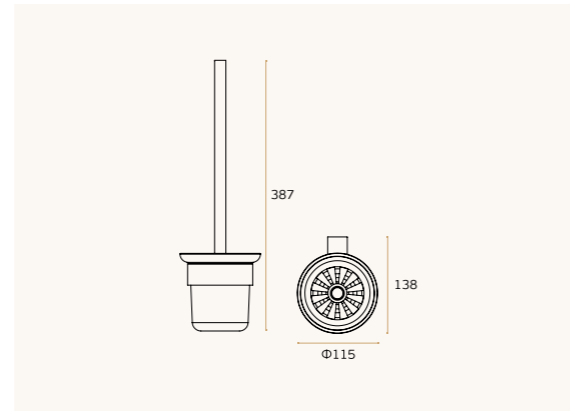

BATHROOM ACCESSORIES / SHOWER SHELF

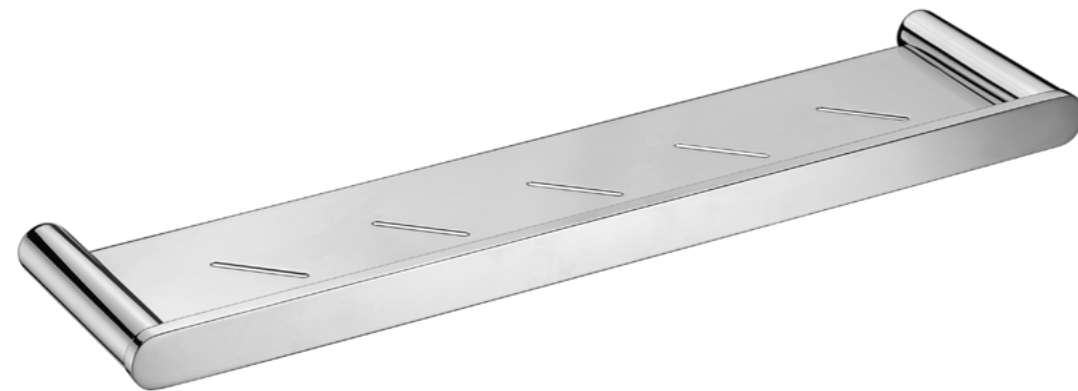

BA82712

Material:SUS304

Type: Shower shelf

Available Finishes:
SSS/ PSS/ PVD-SG/ Matt Black/Brushed Nicekl/
Brushed gun metal

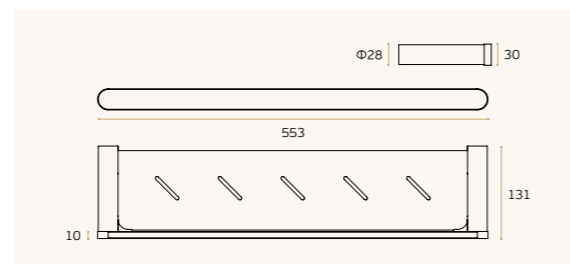

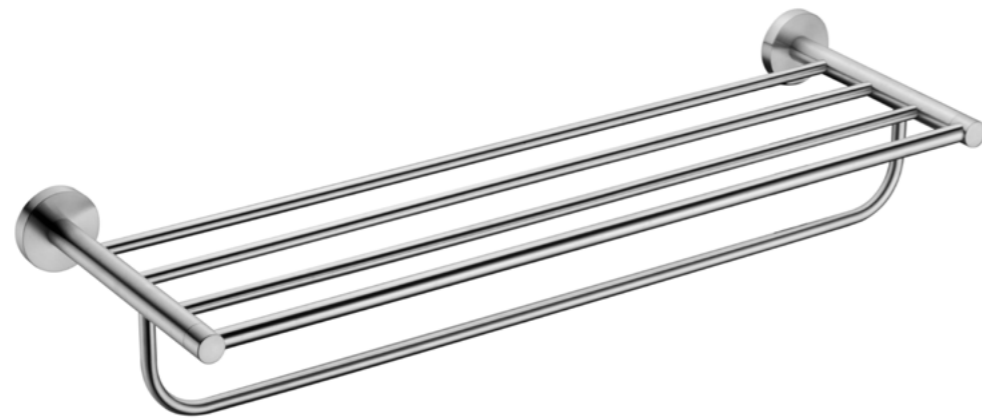
**BATHROOM ACCESSORIES /
TOWEL SHELF****BA90302**

Material:SUS304
Type: Towel shelf
Available Finishes:
 SSS/ PSS/ PVD-SG/ Matt Black/Brushed Nicekl/
 Brushed gun metal

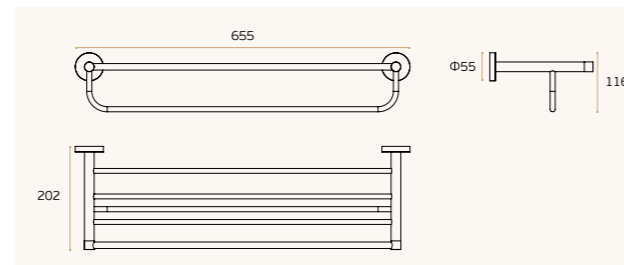
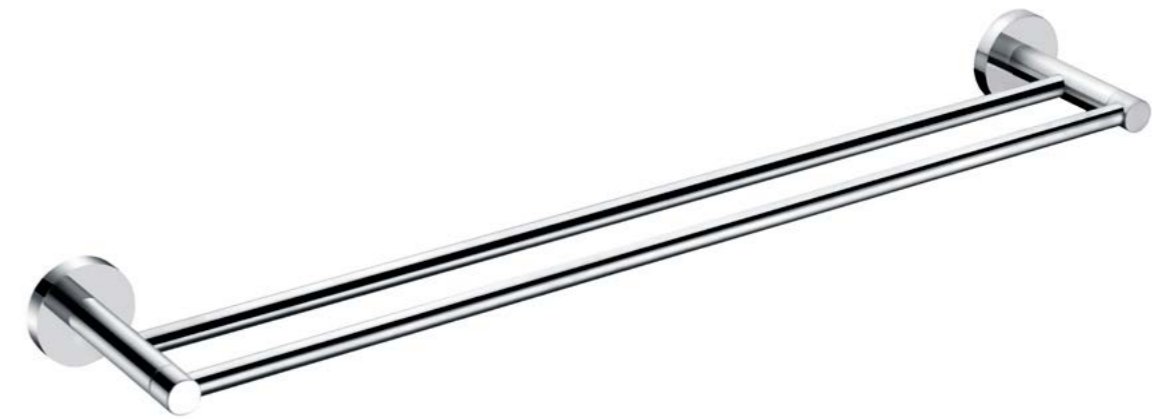
**BATHROOM ACCESSORIES /
TOWEL RAIL****BA90304**

Material:SUS304
Type: Towel rail
Available Finishes:
 SSS/ PSS/ PVD-SG/ Matt Black/Brushed Nicekl/
 Brushed gun metal

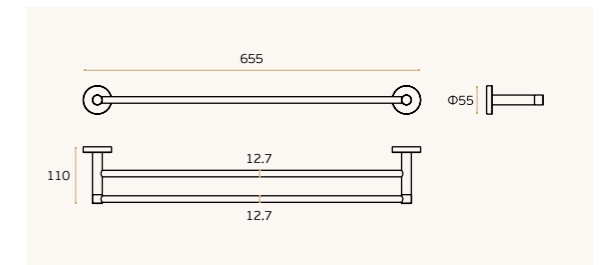
**BATHROOM ACCESSORIES /
TOWEL RAIL****BA90303**

Material:SUS304
Type: Towel rail
Available Finishes:
 SSS/ PSS/ PVD-SG/ Matt Black/Brushed Nicekl/
 Brushed gun metal

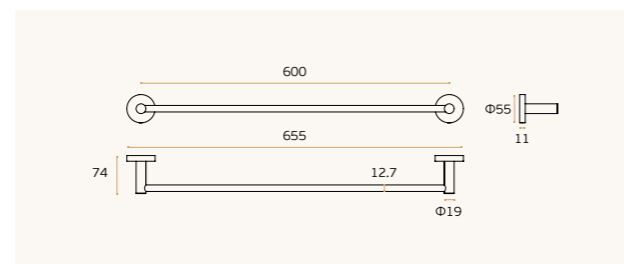

**BATHROOM ACCESSORIES /
SOAP DISH****BA90305**

Material:SUS304
Type: BA90306
Available Finishes:
SSS/ PSS/ PVD-SG/ Matt Black/Brushed Nicekl/
Brushed gun metal

**BATHROOM ACCESSORIES /
GLASS HOLDER****BA90306**

Material:SUS304
Type: Glass
holder**Available Finishes:**
SSS/ PSS/ PVD-SG/ Matt
Black/Brushed Nicekl/
Brushed gun metal

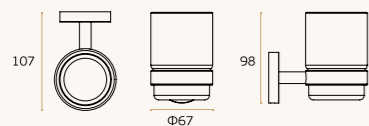
**BATHROOM ACCESSORIES /
PAPER HOLDER****BA90307**

Material:SUS304
Type: Paper holder
Available Finishes:
SSS/ PSS/ PVD-SG/ Matt Black/
Brushed Nicekl/Brushed gun
metal

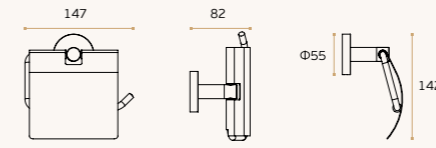
**BA90307A**

Material:SUS304
Type: Paper holder
Available Finishes:
SSS/ PSS/ PVD-SG/ Matt Black/
Brushed Nicekl/Brushed gun
metal

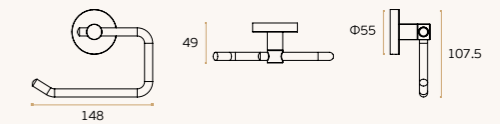
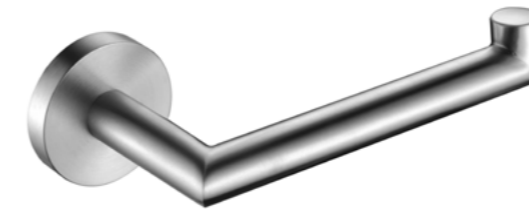
**BATHROOM ACCESSORIES /
SPARE PAPER HOLDER****BA90307B**

Material:SUS304
Type: Paper holder
Available Finishes:
SSS/ PSS/ PVD-SG/ Matt Black/Brushed Nicekl/
Brushed gun metal

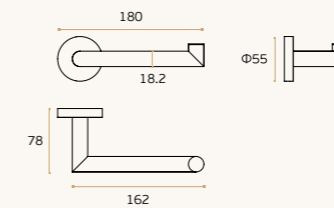
**BA90307C**

Material:SUS304
Type: Spare Paper holder
Available Finishes:
SSS/ PSS/ PVD-SG/ Matt Black/
Brushed Nicekl/Brushed gun metal

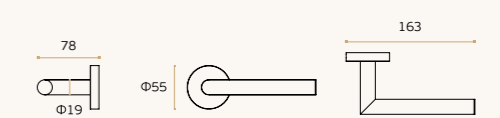

BATHROOM ACCESSORIES / SWIVEL TOWEL HOLDER



BA90308

Material:SUS304
Type: Swivel towel holder
Available Finishes: SSS/ PSS/ PVD-SG/ Matt Black/Brushed Nicekl/ Brushed gun metal

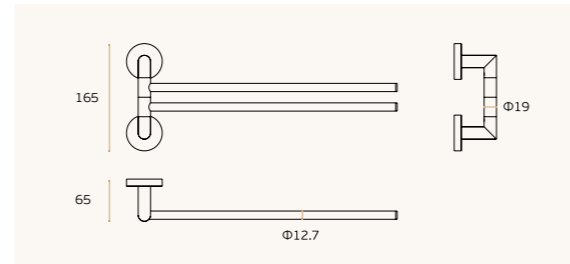

BA90309A

Material:SUS304
Type: Hook
Available Finishes: SSS/ PSS/ PVD-SG/ Matt Black/Brushed Nicekl/ Brushed gun metal

BA90309B

Material:SUS304
Type: Hook
Available Finishes: SSS/ PSS/ PVD-SG/ Matt Black/Brushed Nicekl/ Brushed gun metal

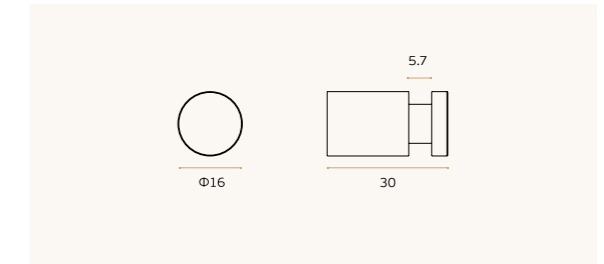
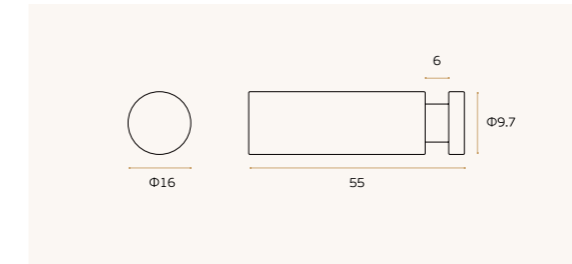

BATHROOM ACCESSORIES / TOWEL RING



BA90308D

Material:SUS304
Type: Towel ring
Available Finishes: SSS/ PSS/ PVD-SG/ Matt Black/ Brushed Nicekl/Brushed gun metal

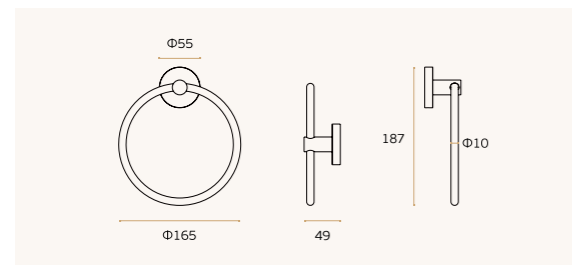

BATHROOM ACCESSORIES / HOOK



BA90309

Material:SUS304
Type: Hook
Available Finishes: SSS/ PSS/ PVD-SG/ Matt Black/Brushed Nicekl/ Brushed gun metal

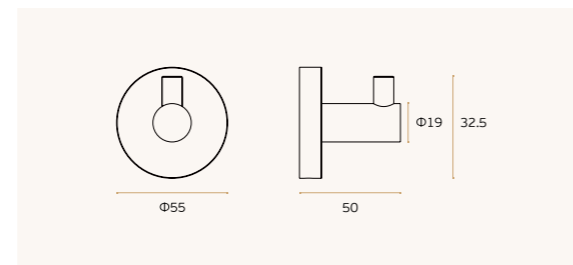

BA90310

Material:SUS304
Type: Hook
Available Finishes: SSS/ PSS/ PVD-SG/ Matt Black/Brushed Nicekl/ Brushed gun metal

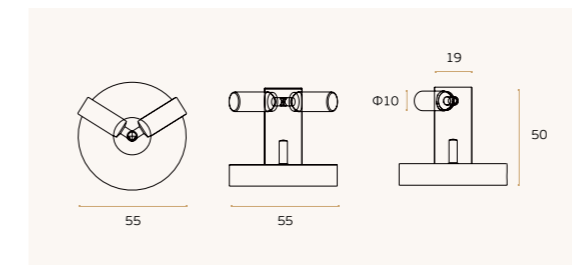

BATHROOM ACCESSORIES / HOOK

BATHROOM ACCESSORIES / TOILET BRUSH HOLDER



BA90311

Material:SUS304
Type: Toilet brush holder
Available Finishes:
 SSS/ PSS/ PVD-SG/ Matt Black/Brushed Nicekl/
 Brushed gun metal

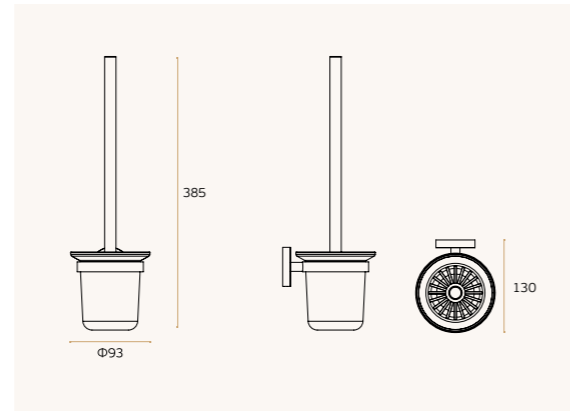

BA90311A

Material:SUS304
Type: Toilet brush holder
Available Finishes:
 SSS/ PSS/ PVD-SG/ Matt Black/Brushed Nicekl/
 Brushed gun metal

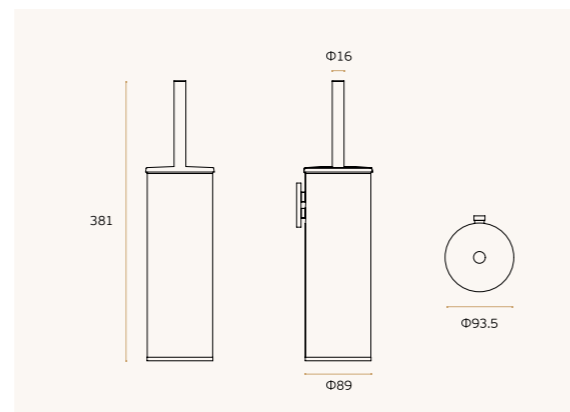

BATHROOM ACCESSORIES / PAPER HOLDER

BA78740

Material:SUS304
Type: Paper holder
Available Finishes:
 SSS/ PSS/ PVD-SG/ Matt Black/
 Brushed Nicekl/Brushed gun metal

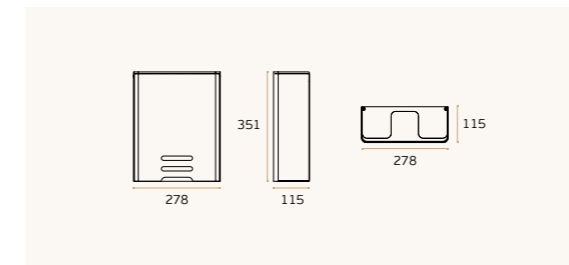

BA78760

Material:SUS304
Type: Paper holder
Available Finishes:
 SSS/ PSS/ PVD-SG/ Matt Black/
 Brushed Nicekl/Brushed gun metal

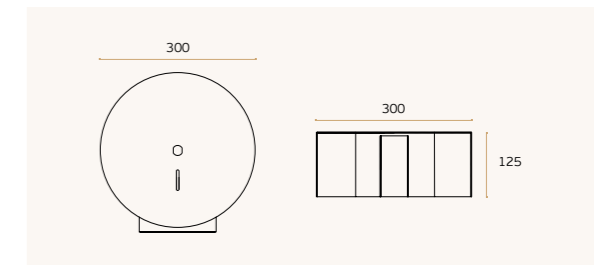

BATHROOM ACCESSORIES / DUSTBIN

BA78780

Material:SUS304
Type: Dustbin
Available Finishes:
 SSS/ PSS/ PVD-SG/ Matt Black/
 Brushed Nicekl/Brushed gun metal

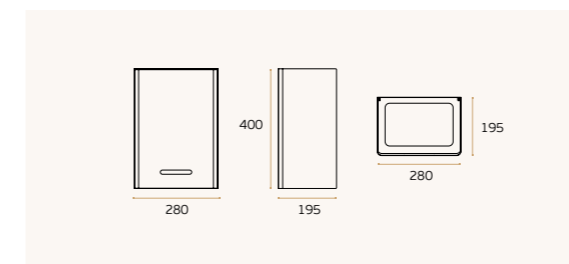

www.hangfatmetal.com

JIANGMEN HANGFAT METAL PRODUCTS FACTORY

Address: Nacikeng Industrial District, Duruan Town,
Jiangmen City, Guangdong Province, China, 529075

Tel: +86 750 3663332 **Fax:** +86 750 3663442

E-mail: sales@hangfatmetal.com mulang@hangfatmetal.com

