

**ARCHITECTURE
HARDWARE
ACCESSORIES**





HANGFAT was established in Jiangmen, China, 1994. It is a classic Chinese metal product brand with a history of 30 years.

We set product development, manufacturing and independent marketing in one, and always insist that the details are king. That is how we were born, grew and become powerful.

HANGFAT provide OEM/ODM service for our customers. Adequate machines and production lines can achieve a monthly production capacity of 800,000 pairs/set. Our product lines cover stainless steel handles, turn knobs, back plates, locksets, hinges and so on.

In the past years, HANGFAT stuck to the strict raw material inspection & acceptance standards and material distribution system. We continue to innovate production processes to reduce production spoilage, achieving better cost and quality control.

HANGFAT believes important people need more professional protection. All the important objects of protection can be "Safe, always around"!

"PIONEER ROLE" -focus, professional, leading!

OUR TEAM

Core belief: Through expertise and love, for more space to achieve hand-in-hand security system.

Mission: Important people, need more professional guarding.

Vision: "Pioneer role"-Focus, Professional, Leading.

Value: All important objects of protection can be "Safe, always around".



江门恒發金屬



Take Safety with You

把握安全，常伴左右

TAKE SAFETY WITH YOU

DETAILS ARE KING

HANGFAT was established in Jiangmen, China, 1994.
It is an classic Chinese metal product brand with a
history of 30 years.

We set product development, manufacturing and
independent marketing in one, and always insist that
the details are king.

That is how we were born, grew and become powerful.

AUTOMATION MORE PROFESSIONAL

HANGFAT has technicians with decades of industry experience
Their production precision is close to the machine.
But for this "close",
We insist on introducing dozens of new & advanced machines.

3D automatic welding machine is highly efficient and accurate, ensuring uniform, stable and beautiful appearance of each solder joint;
Automatic polishing machine for every detail of the product has a delicate, smooth texture, and shiny;
Laser marking machine, high-speed, exquisite lines, to ensure the quality of our products and production capacity;

.....

We are always dedicated to speciality and meticulousness, perfecting every detail and making every product reliable.



QUALITY IS MARKET

HANGFAT provide OEM/ODM service for our customers. Adequate machines and production lines can achieve a monthly production capacity of 800,000 pairs/set. Our product line covers stainless steel handles, turnknobs, back plates, locksets, hinges and so on.

In the past 30 years, HANGFAT stuck to the strict raw material inspection & acceptance standards and material distribution system. We follow the principle of first-in, first-out in inventory control. 12 quality inspection processes ensure that each product undergoes rigorous testing before it can be distributed on the market.





INNOVATION LEADS FUTURE

HANGFAT continues to innovate production processes to reduce production spoilage, thereby achieving better cost and quality control. At the same time, we are constantly optimizing product design, focusing on the fit of technology and life, and presenting the natural beauty with texture.

Each of HANGFAT's products is comfortable, safe and beautiful, meeting the needs of modern life and suitable for a variety of modern home styles.

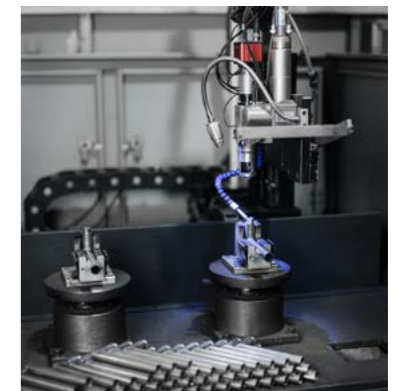
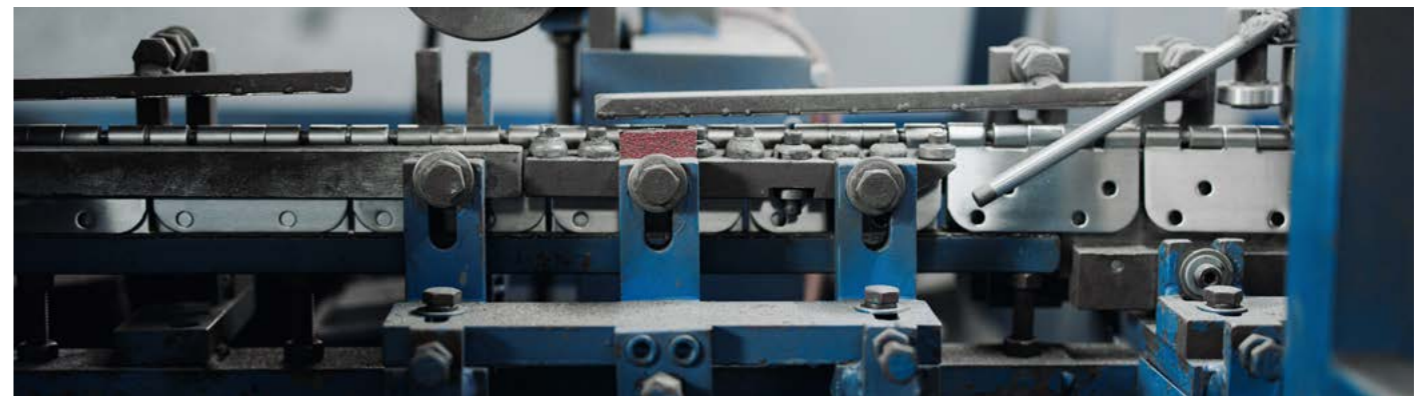

HANGFAT CERTIFICATIONS



Certificate of Environmental Management System



Certificate of Quality Management System



Pollutant Emission Permit



CE Certificate

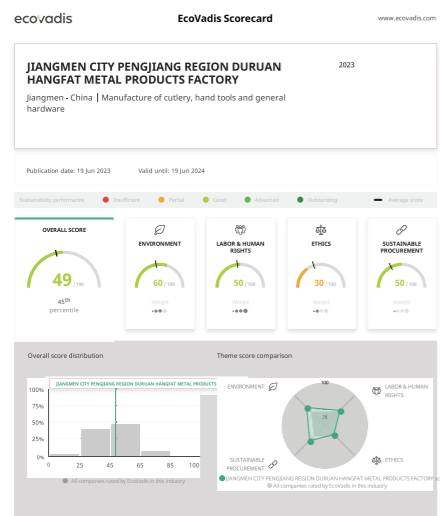

ESG Certificate



Work Safety Standardization Certificate (Level 3)



RoHS Certificate

Intertek TEST REPORT
Performance test

Report Reference No.: G271212284
Tested by (name and signature): Alan Lai
Approved by (name and signature): Bikang Dong
Date of issue: January 23, 2019
Contents: Total test report 9 pages including Report test: 3 pages Appendix A for product photos: 2 pages

Testing Laboratory name: Intertek Testing Services (Shenzhen) Ltd. Guangdong Branch
Address: Block E, No.7-2 Huang Dong Software Science Park, Cuijin Road, Guangzhou Science City, GZTDD, Guangzhou, China
Testing location: Same as above
Applicant's name: JIANGMEN CITY PENGJIANG REGION DURUAN HANGFAT METAL PRODUCTS FACTORY
Address: NANCHANG INDUSTRIAL DISTRICT, DURUAN TOWN, JIANGMEN CITY, GUANGDONG PROV., CHINA (529075)

Test specification:
Standard: EN 1670:2007AC:2009
Non-standard test method: S12324 Stainless steel 2 ball bearing ball hinge
Test item description: S12324 Stainless steel 2 ball bearing ball hinge
Trade Mark: /
Model and/or type reference: E'X3 E'X3.0mm
Manufacturer: JIANGMEN CITY PENGJIANG REGION DURUAN HANGFAT METAL PRODUCTS FACTORY
Rating(s): Grade 4 (340 hours) Corrosion Resistance (neutral salt spray)

CONCLUSION
The submitted samples were tested and **COMPLIED WITH** Grade 4 Corrosion Resistance of EN 1670:2007AC:2009

Intertek Testing Services (Shenzhen) Ltd., Guangdong Branch
Block E, No.7-2 Huang Dong Software Science Park, Cuijin Road, Guangzhou Science City, GZTDD, Guangzhou, China
Tel: 86 020 67199881 Fax: 86 020 67199880

EN1670 Performance Test Report

HANGFAT CERTIFICATIONS



EN1906 Grade 3 Certificate



EN1906 Grade 4 Certificate



EN1906 Grade 4 Certificate



EN1935 Grade 14 Certificate



Utility Model Patent



Utility Model Patent



Utility Model Patent



Utility Model Patent



Utility Model Patent



Utility Model Patent



Appearance Design Patent



Appearance Design Patent

Door direction

The door direction(left/right)according to DIN 107 is determined as follows:

Visible position of the door hinges on the left: **(Din)left**

Visible position of the door hinges on the right: **(Din)right**

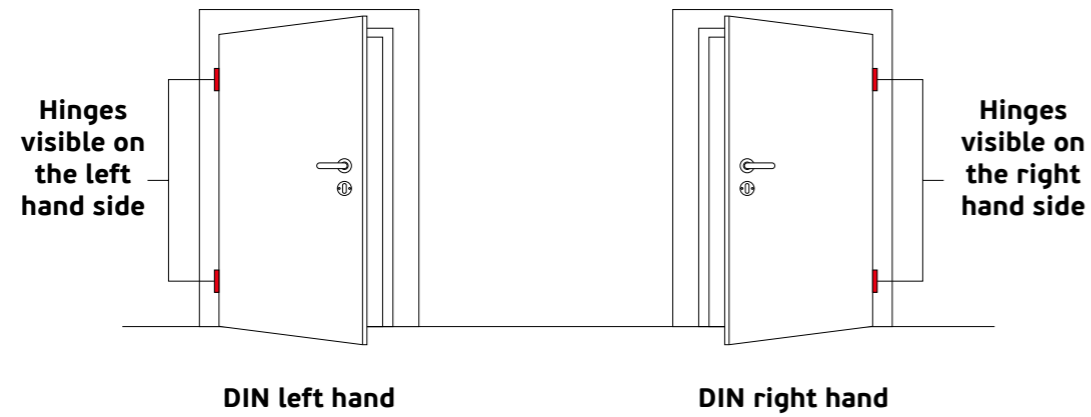

Door opening direction

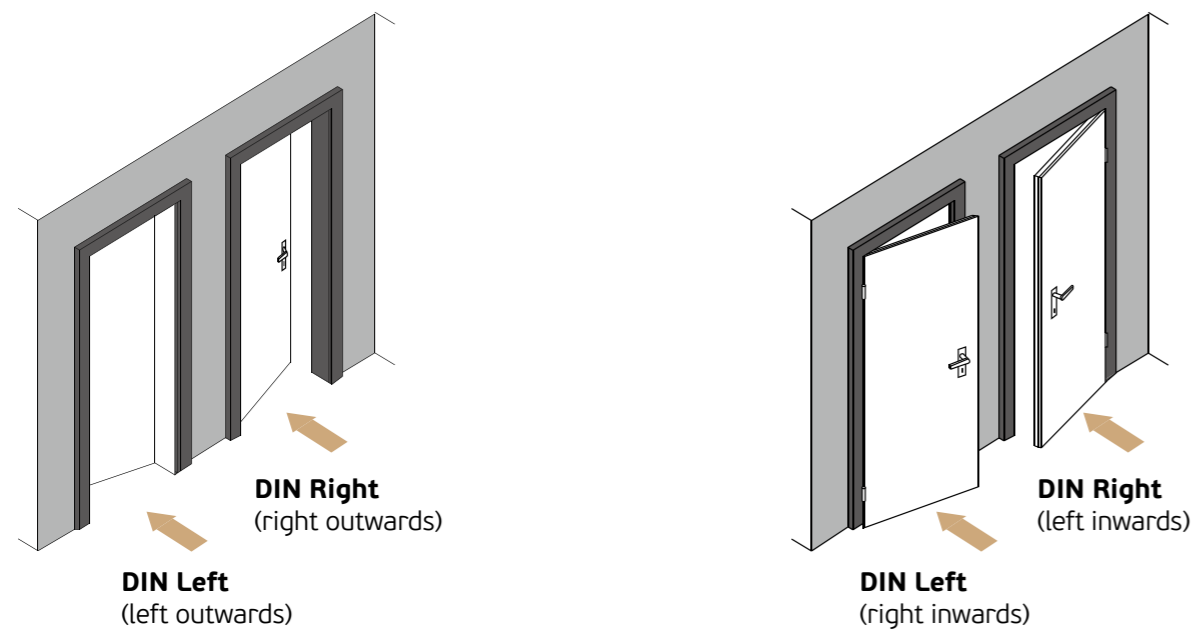

Lever handle direction

Lever handle aperture part pointing to the left

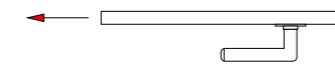

Version "left hand"

Lever handle aperture part pointing to the right

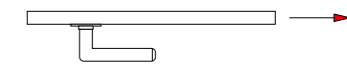

Version "right hand"

When selecting alternate sets with asymmetrical handles a distinction to the right/left is required. It is therefore necessary to observe the particular door direction.

Examples of asymmetric lever handles

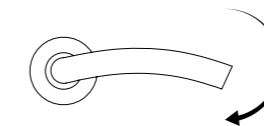

Examples of symmetrical lever handles

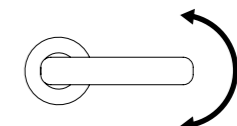



SSS-Satin



PSS-Polished



PVDSG-PVD Satin Gold



PVDPG-PVD Polished Gold



PVDSM-PVD Matt Black



CRS-PVD Satin Chrome



PVDSM-PVD Satin Copper



CRP-PVD Polished Chrome

FINISH TREATMENT

HANGFAT's factory finish paint offers a variety of popular standard color choices along with custom match options. The finish paint is applied to our quality commercial products, carefully packaged and supplied to our customer, pre-finished. Our efficient method of application and pre-finished delivery saves in money and time - from a brand you know and trust.

ACCESSORIES COMMON SIZE

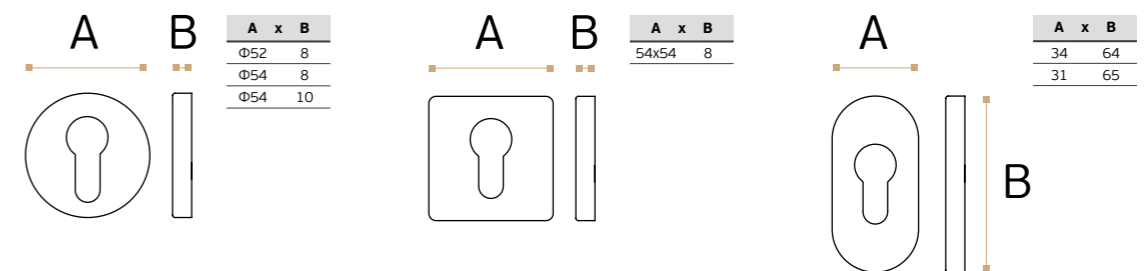
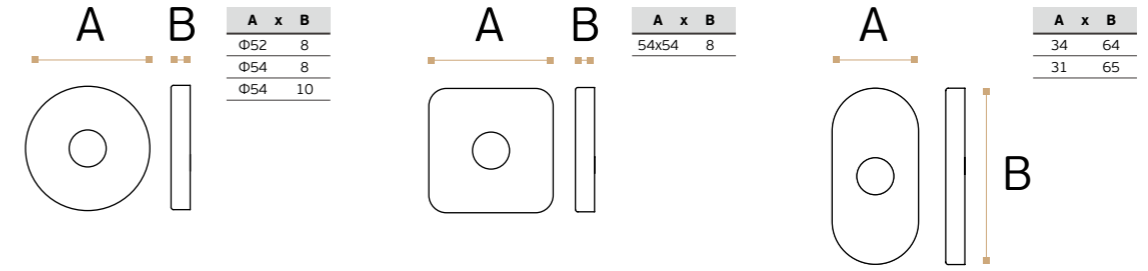

ICON DEFINITION

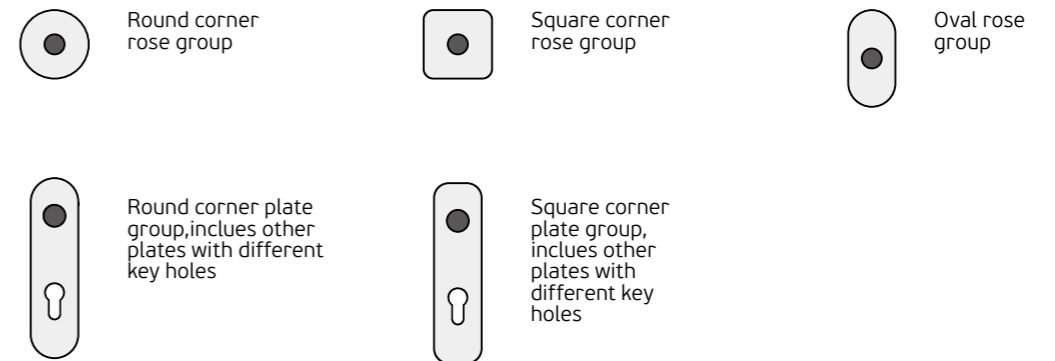

ARCHITECTURE HARDWARE ACCESSORIES

We use with a strict quality control system. The management of resources associated with a significant stock control give us an ability to get better balance between price and quality and to respond to our clients requirements very quickly. By the ongoing development of our product line, we have been placed as a leading company in local markets.

The architecture hardware accessories in this catalog are divided into the following groups:

Door stoppers

Signatures

Furniture Handles

Flush Pulls

Flush Bolts

Door Selector

Switch

Door Guard

Door Viewer

Letter Plates

Dust Proof Socket

Handlerail Bracket

Hooks



ARCHITECTURE HARDWARE ACCESSORIES / DOOR STOPPER



DS01

Material:SUS304 / SUS316

Type: Door Stopper

Available Finishes: SSS / PSS / AB / PC / PVD-SG/PG/
SC/CRP/CRS

Application:For wall fixing

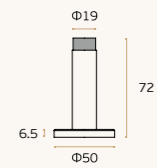

DS02

Material:SUS304 / SUS316

Type: Door Stopper

Available Finishes: SSS / PSS / AB / PC / PVD-SG/PG/
SC/CRP/CRS

Application:For floor fixing

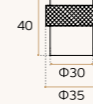

DS05

Material:SUS304 / SUS316

Type: Door Stopper

Available Finishes: SSS / PSS / AB / PC / PVD-SG/PG/
SC/CRP/CRS

Application:For wall fixing

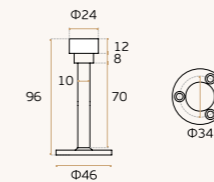

DS06

Material:SUS304 / SUS316

Type: Door Stopper

Available Finishes: SSS / PSS / AB / PC / PVD-SG/PG/
SC/CRP/CRS

Application:For wall fixing

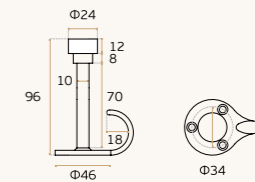

DS03

Material:SUS304 / SUS316

Type: Door Stopper

Available Finishes: SSS / PSS / AB / PC / PVD-SG/PG/
SC/CRP/CRS

Application:For floor fixing

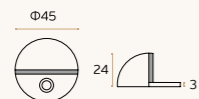

DS04

Material:SUS304 / SUS316

Type: Door Stopper

Available Finishes: SSS / PSS / AB / PC / PVD-SG/PG/
SC/CRP/CRS

Application:For floor fixing

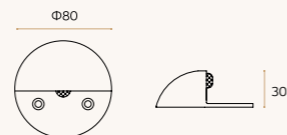

DS07

Material:SUS304 / SUS316

Type: Door Stopper

Available Finishes: SSS / PSS / AB / PC / PVD-SG/PG/
SC/CRP/CRS

Application:For wall fixing

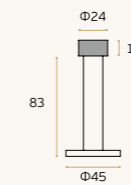

DS08

Material:SUS304 / SUS316

Type: Door Stopper

Available Finishes: SSS / PSS / AB / PC / PVD-SG/PG/
SC/CRP/CRS

Application:For wall fixing

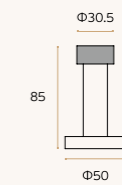

ARCHITECTURE HARDWARE ACCESSORIES / DOOR STOPPER



DS09

Material:SUS304 / SUS316
Type: Door Stopper
Available Finishes: SSS / PSS / AB / PC / PVD-SG/PG/ SC/CRP/CRS
Application:For floor fixing

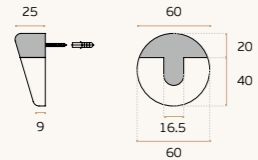

DS10

Material:SUS304 / SUS316
Type: Door Stopper
Available Finishes: SSS / PSS / AB / PC / PVD-SG/PG/ SC/CRP/CRS
Application:For floor fixing

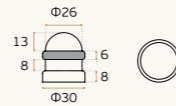

DS13

Material:SUS304 / SUS316
Type: Door Stopper
Available Finishes: SSS / PSS / AB / PC / PVD-SG/PG/ SC/CRP/CRS
Application:For wall fixing



DS14

Material:SUS304 / SUS316
Type: Door Stopper
Available Finishes: SSS / PSS / AB / PC / PVD-SG/PG/ SC/CRP/CRS
Application:For floor fixing

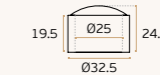
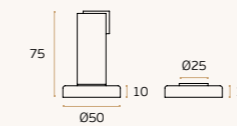

DS11

Material:SUS304 / SUS316
Type: Door Stopper
Available Finishes: SSS / PSS / AB / PC / PVD-SG/PG/ SC/CRP/CRS
Application:For floor fixing

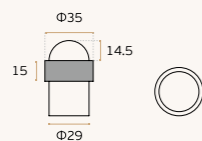

DS12

Material:SUS304 / SUS316
Type: Door Stopper
Available Finishes: SSS / PSS / AB / PC / PVD-SG/PG/ SC/CRP/CRS
Application:For wall fixing



DS15

Material:SUS304 / SUS316
Type: Door Stopper
Available Finishes: SSS / PSS / AB / PC / PVD-SG/PG/ SC/CRP/CRS
Application:For wall fixing

L
50
86

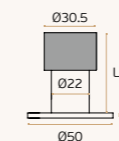

STAINLESS STEEL SIGNATURES



SN19

Material:SUS304 / SUS316
Type: Signatures
Available Finishes:
SSS / PSS / AB / PC / PVD-SG/PG/SC/CRP/CRS
Application:Installation trough screws

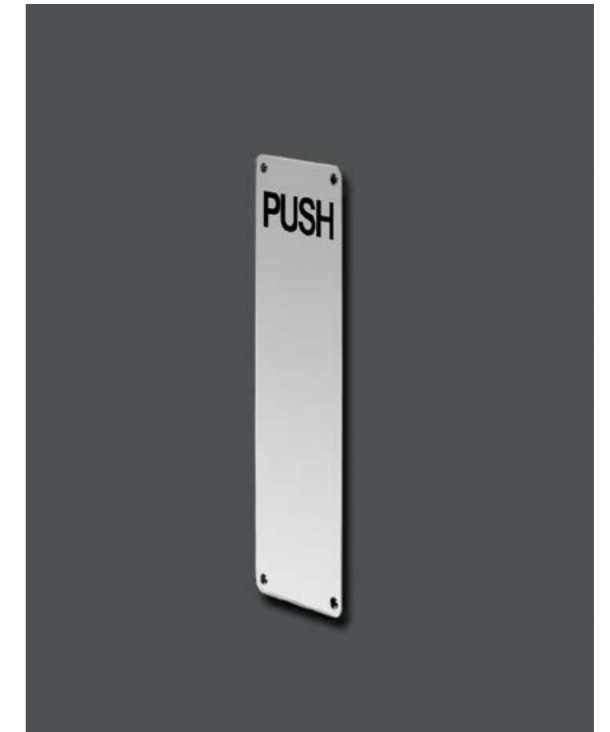
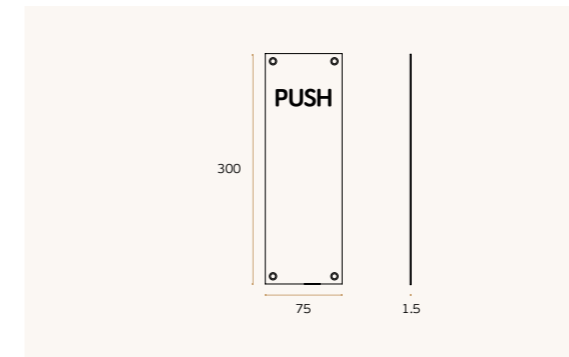

SN23

Material:SUS304 / SUS316
Type: Signatures
Available Finishes:
SSS / PSS / AB / PC / PVD-SG/PG/SC/CRP/CRS
Application:Installation trough screws

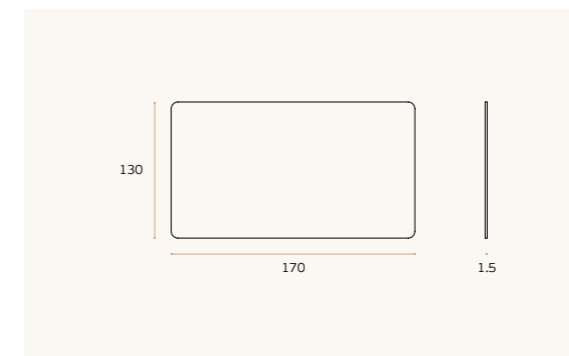

ARCHITECTURE HARDWARE ACCESSORIES / SIGNATURES

Material:SUS304 / SUS316
Type: Signatures
Available Finishes: SSS / PSS / AB / PC / PVD-SG/PG/SC/CRP/CRS
Application: Installation with strong adhesive fixing

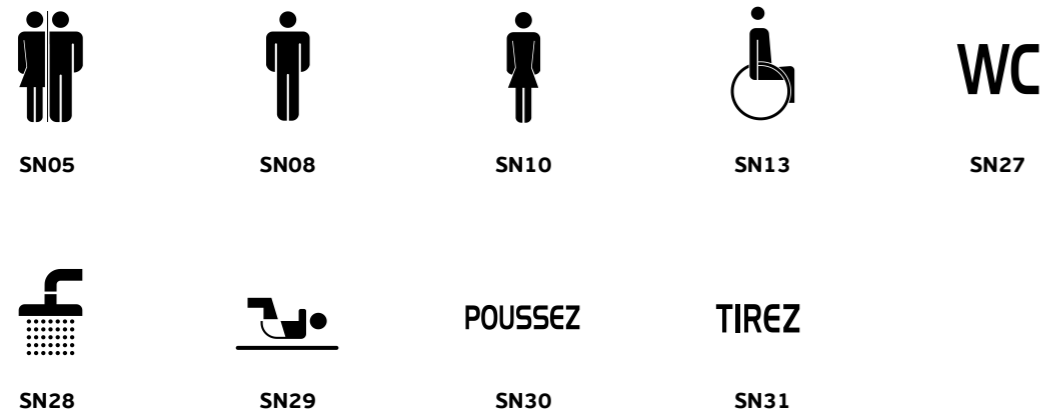
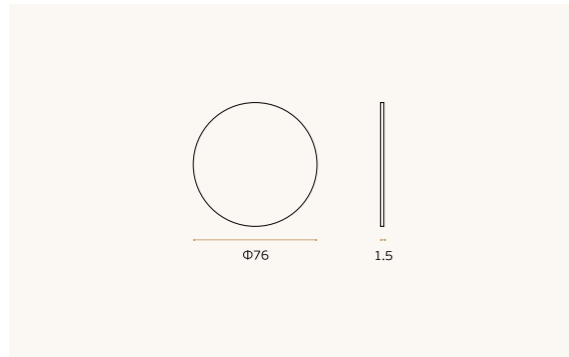

AN-0/.../9
Material:SUS304 / SUS316
Type: Signatures
Available Finishes: SSS / PSS / AB / PC / PVD-SG/PG/SC/CRP/CRS
Application: Installation with strong adhesive fixing

L
120
150

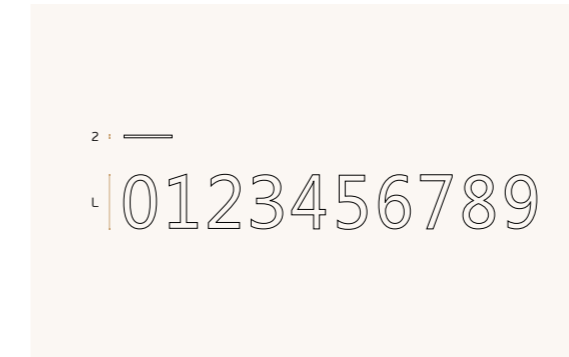

AN-a/.../d
Material:SUS304 / SUS316
Type: Signatures
Available Finishes: SSS / PSS / AB / PC / PVD-SG/PG/SC/CRP/CRS
Application: Installation with strong adhesive fixing



ARCHITECTURE HARDWARE ACCESSORIES / FURNITURE HANDLE

FH20

Material:SUS304 / SUS316
Type: Furniture Handle
Available Finishes: SSS / PSS / AB / PC / PVD-SG/PG/SC/CRP/CRS

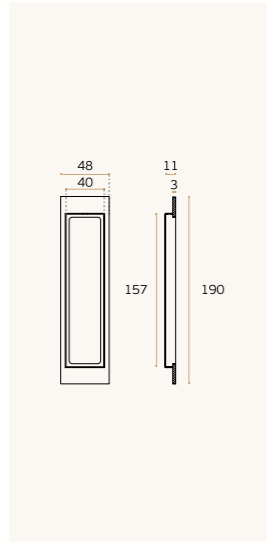

FH21

Material:SUS304 / SUS316
Type: Furniture Handle
Available Finishes: SSS / PSS / AB / PC / PVD-SG/PG/SC/CRP/CRS

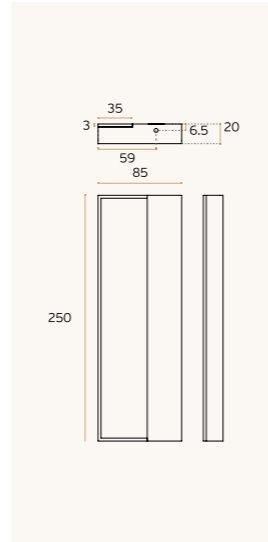

FH02

Material:SUS304 / SUS316
Type: Furniture Handle
Available Finishes: SSS / PSS / AB / PC / PVD-SG/PG/SC/CRP/CRS



A
65
90

FH03

Material:SUS304 / SUS316
Type: Furniture Handle
Available Finishes: SSS / PSS / AB / PC / PVD-SG/PG/SC/CRP/CRS



A
30
40
50
60

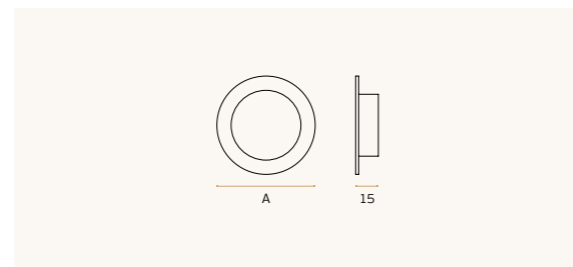
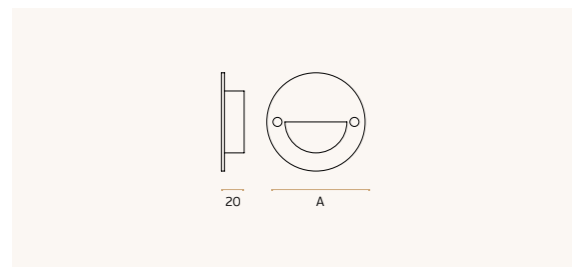

FH04

Material:SUS304 / SUS316
Type: Furniture Handle
Available Finishes: SSS / PSS / AB / PC / PVD-SG/PG/SC/CRP/CRS

A
70
50
40
30

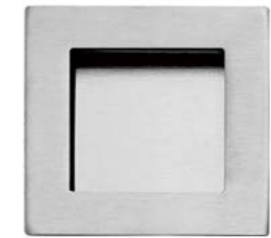
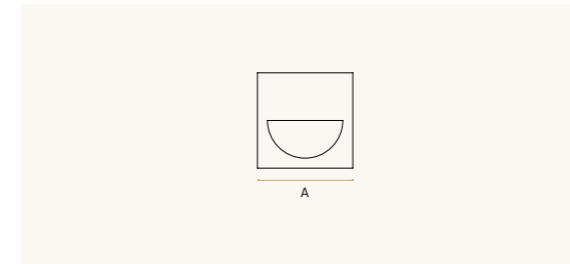

FH05

Material:SUS304 / SUS316
Type: Furniture Handle
Available Finishes: SSS / PSS / AB / PC / PVD-SG/PG/SC/CRP/CRS

A
70
50
30

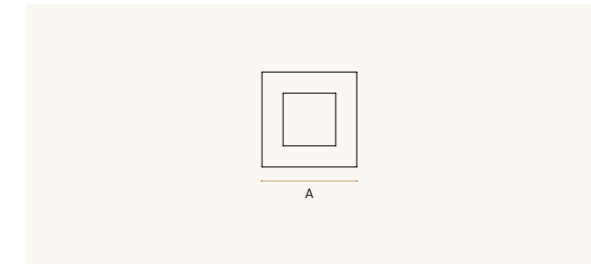

FH01

Material:SUS304 / SUS316
Type: Furniture Handle
Available Finishes: SSS / PSS / AB / PC / PVD-SG/PG/SC/CRP/CRS

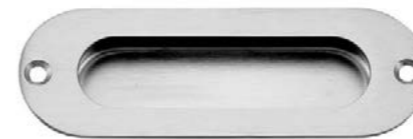

A	B
40	14
60	15

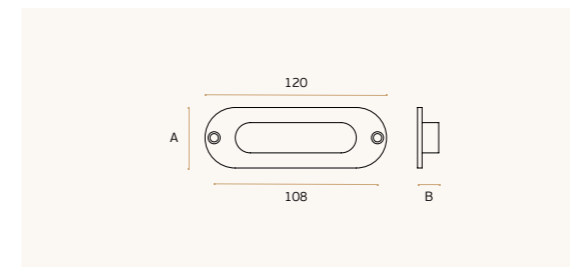

FH12

Material:SUS304 / SUS316
Type: Furniture Handle
Available Finishes: SSS / PSS / AB / PC / PVD-SG/PG/SC/CRP/CRS

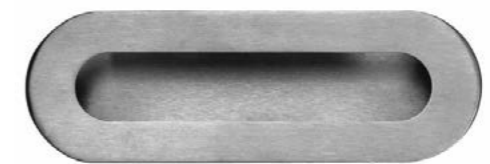

A	B	C
170	58	16
120	40	12

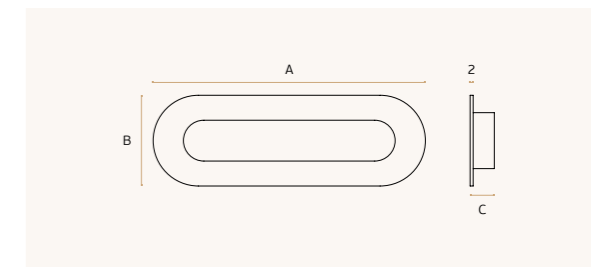

ARCHITECTURE HARDWARE ACCESSORIES / FURNITURE HANDLE

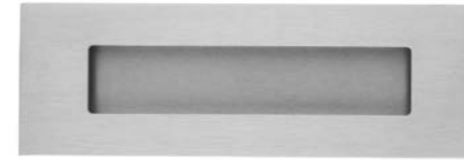
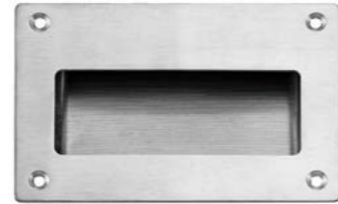
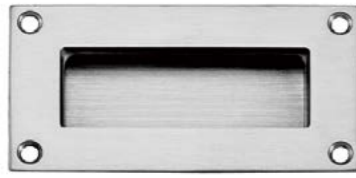

FH06

Material: SUS304 / SUS316

Type: Furniture Handle

Available Finishes:

SSS / PSS / AB / PC / PVD-SG/PG/SC/CRP/CRS

A	B	C	D
102	90	39	51
105	113	39	51
150	138	39	51

FH10

Material: SUS304 / SUS316

Type: Furniture Handle

Available Finishes: SSS / PSS / AB / PC / PVD-SG/PG/SC/CRP/CRS

FH09

Material: SUS304 / SUS316

Type: Furniture Handle

Available Finishes: SSS / PSS / AB / PC / PVD-SG/PG/SC/CRP/CRS

FH07

Material: SUS304 / SUS316

Type: Furniture Handle

Available Finishes: SSS / PSS / AB / PC / PVD-SG/PG/SC/CRP/CRS

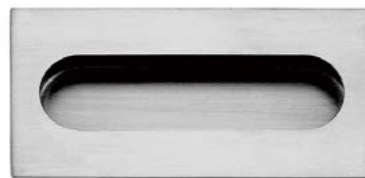
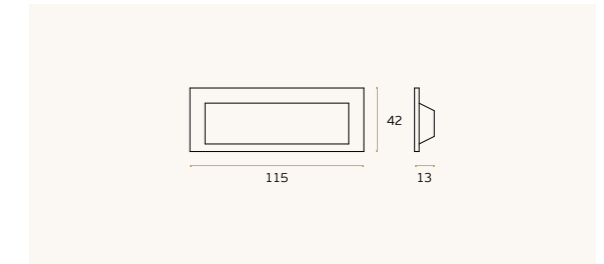
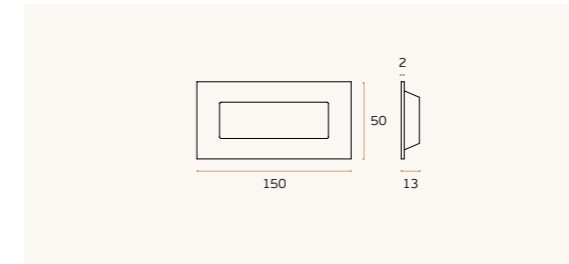
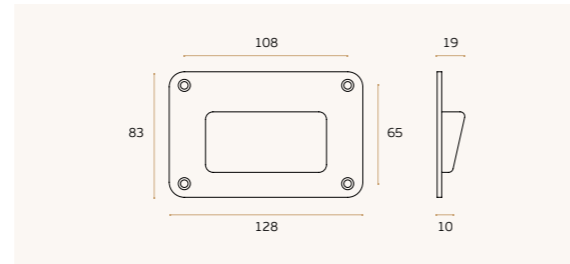
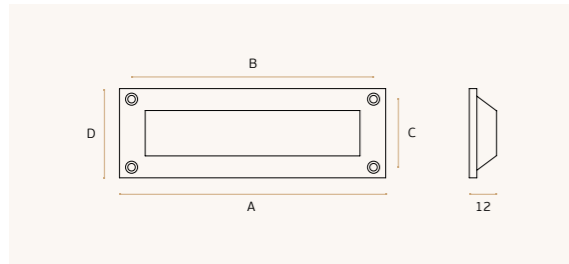

FH08

Material: SUS304 / SUS316

Type: Furniture Handle

Available Finishes: SSS / PSS / AB / PC / PVD-SG/PG/SC/CRP/CRS

FH19

Material: SUS304 / SUS316

Type: Furniture Handle

Available Finishes: SSS / PSS / AB / PC / PVD-SG/PG/SC/CRP/CRS

FH14

Material: SUS304 / SUS316

Type: Furniture Handle

Available Finishes: SSS / PSS / AB / PC / PVD-SG/PG/SC/CRP/CRS

A	B	C
80	36	14
115	42	14

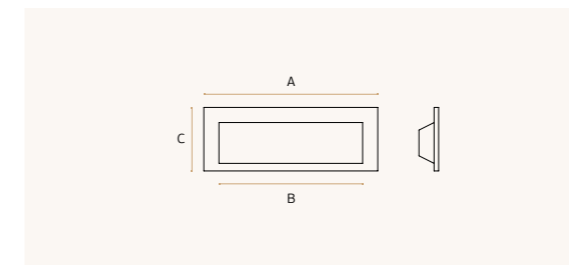
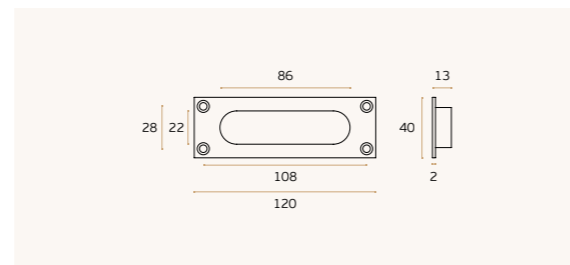
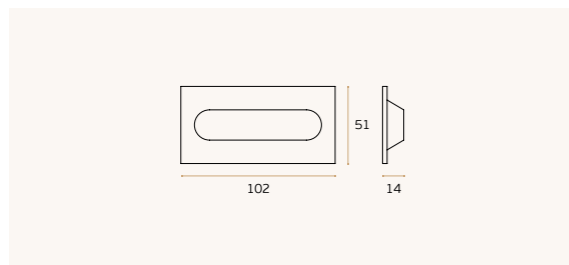

ARCHITECTURE HARDWARE ACCESSORIES / FURNITURE HANDLE



FH15
Material:SUS304 / SUS316
Type: Furniture Handle
Available Finishes: SSS / PSS / AB / PC / PVD-SG/PG/SC/CRP/CRS

A
Φ8
Φ10
Φ12
Φ17

FH18
Material:SUS304 / SUS316
Type: Furniture Handle
Available Finishes: SSS / PSS / AB / PC / PVD-SG/PG/SC/CRP/CRS

A
10
12
12.7
14

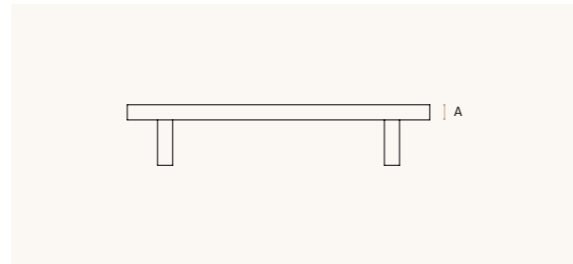
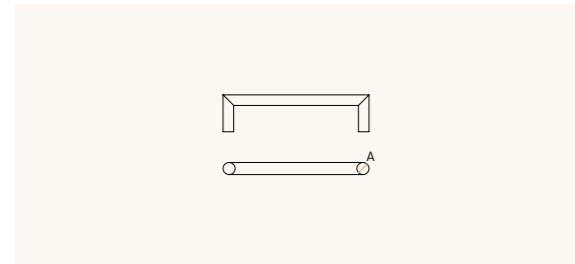
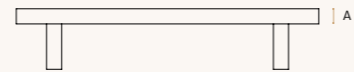
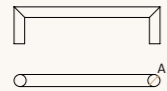

FH16
Material:SUS304 / SUS316
Type: Furniture Handle
Available Finishes: SSS / PSS / AB / PC / PVD-SG/PG/SC/CRP/CRS

A
10
12
15

FH17
Material:SUS304 / SUS316
Type: Furniture Handle
Available Finishes: SSS / PSS / AB / PC / PVD-SG/PG/SC/CRP/CRS

A x B
20 10
30 10
40 10
25 13

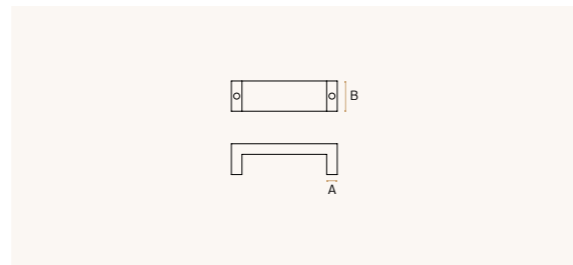
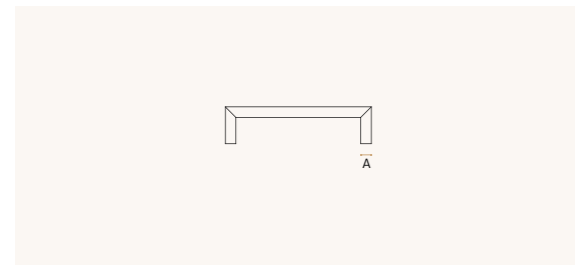
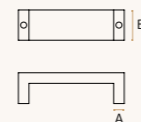

ARCHITECTURE HARDWARE ACCESSORIES / FLUSH PULLS

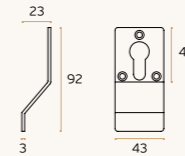

FP03
Material:SUS304 / SUS316
Type: Flush Pull
Available Finishes: SSS / PSS / AB / PC / PVD-SG/PG/SC/CRP/CRS

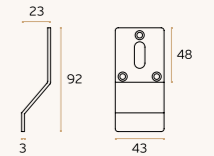

FP06
Material:SUS304 / SUS316
Type: Flush Pull
Available Finishes: SSS / PSS / AB / PC / PVD-SG/PG/SC/CRP/CRS

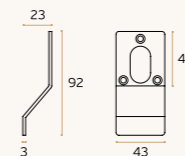

FP04
Material:SUS304 / SUS316
Type: Flush Pull
Available Finishes: SSS / PSS / AB / PC / PVD-SG/PG/SC/CRP/CRS

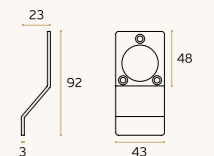

FP05
Material:SUS304 / SUS316
Type: Flush Pull
Available Finishes: SSS / PSS / AB / PC / PVD-SG/PG/SC/CRP/CRS

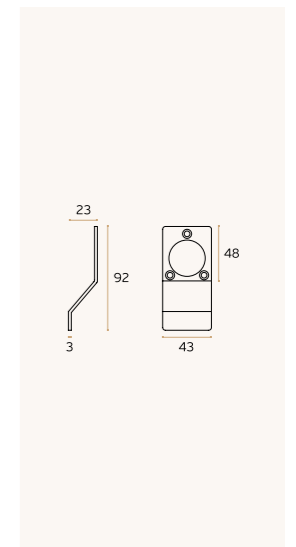
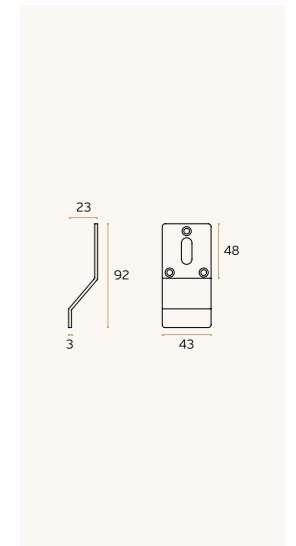
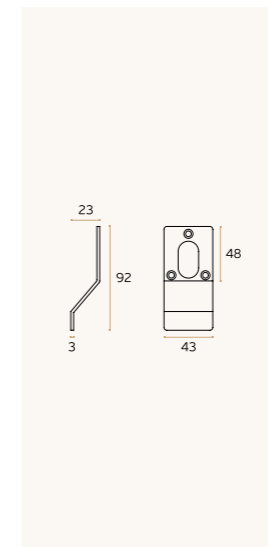
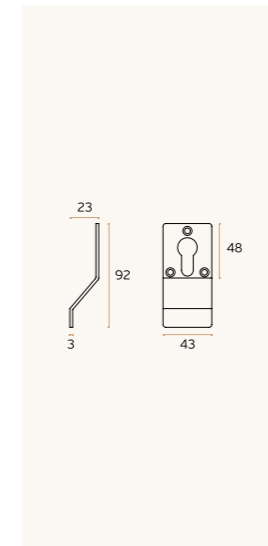

ARCHITECTURE HARDWARE ACCESSORIES / FLUSH BOLTS

FB01

Material:SUS304 / SUS316
Type: Flush Bolts
Available Finishes: SSS / PSS / AB / PC / PVD-SG/PG/ SC/CRP/CRS

- 6"
- 8"
- 10"
- 12"

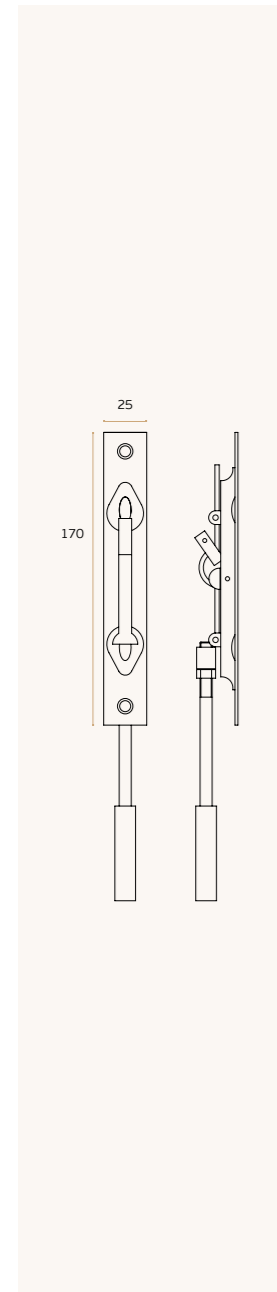

FB02

Material:SUS304 / SUS316
Type: Flush Bolts
Available Finishes: SSS / PSS / AB / PC / PVD-SG/PG/ SC/CRP/CRS

- 6"
- 8"
- 10"
- 12"

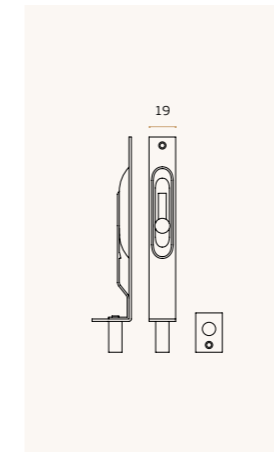

FB03

Material:SUS304 / SUS316
Type: Flush Bolts
Available Finishes: SSS / PSS / AB / PC / PVD-SG/PG/ SC/CRP/CRS

- 6"
- 8"
- 10"
- 12"
- 18"
- 24"

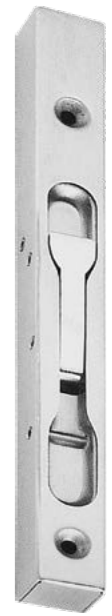
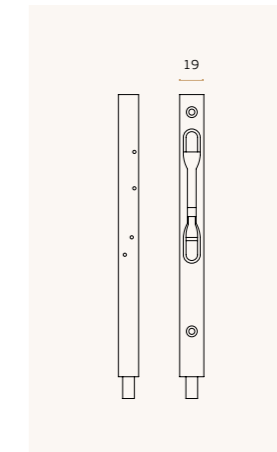

FB04

Material:SUS304 / SUS316
Type: Flush Bolts
Available Finishes: SSS / PSS / PVD-SG/PG/SB/AC

- 6"
- 8"
- 10"
- 12"
- 18"
- 24"

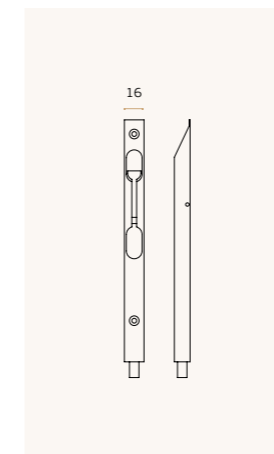

FB05

Material:SUS304 / SUS316
Type: Flush Bolts
Available Finishes: SSS / PSS / PVD-SG/PG/SB/AC

- 6"
- 8"
- 10"
- 12"
- 18"
- 24"

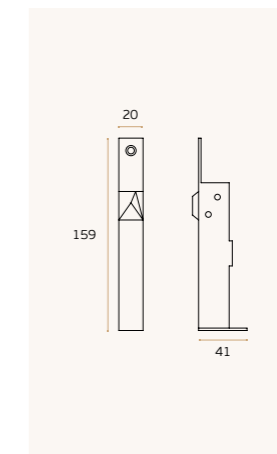

ARCHITECTURE HARDWARE ACCESSORIES / DOOR SELECTOR



Door Selector

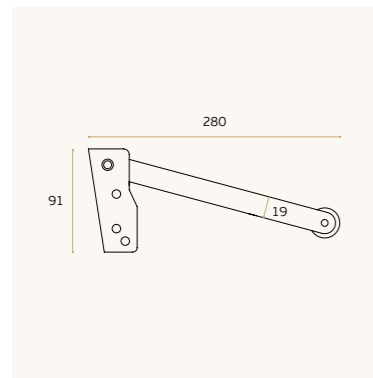

DC01
Material: SUS304 / SUS316
Available Finishes: SSS / PSS / AB / PC / PVD-SG/PG/SC/CRP/CRS



Door Selector

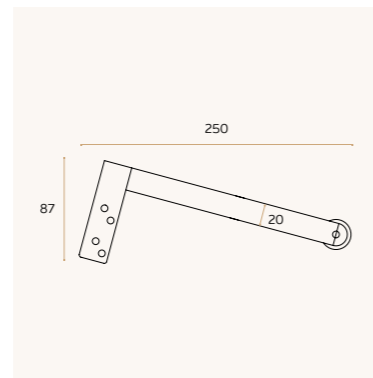

DC02
Material: SUS304 / SUS316
Available Finishes: SSS / PSS / AB / PC / PVD-SG/PG/SC/CRP/CRS

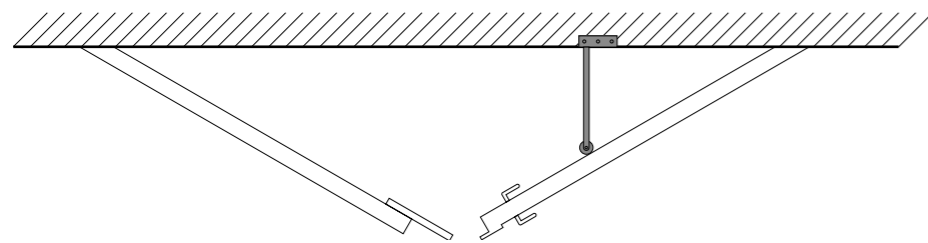

Switch

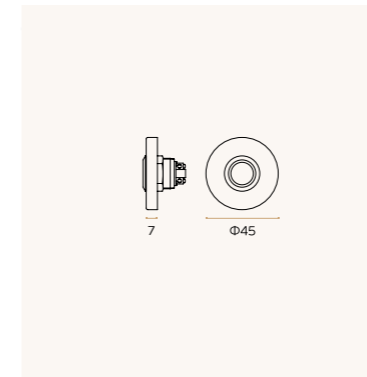

DB01
Material: SUS304 / SUS316
Available Finishes: SSS / PSS / AB / PC / PVD-SG/PG/SC/CRP/CRS

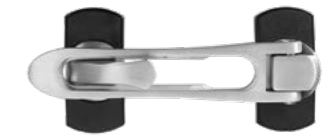

Door Guard

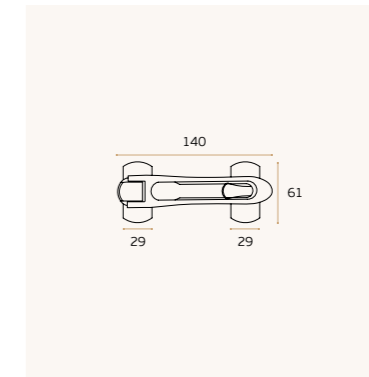

DG01
Material: SUS304 / SUS316
Available Finishes: SSS / PSS / AB / PC / PVD-SG/PG/SC/CRP/CRS

Door Viewer

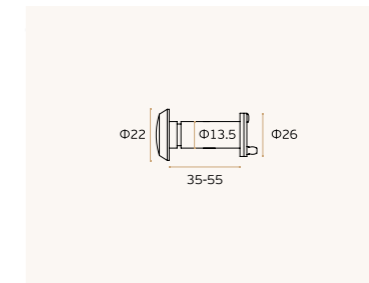

DE01
Material: SUS304 / SUS316
Available Finishes: SSS / PSS / AB / PC / PVD-SG/PG/SC/CRP/CRS

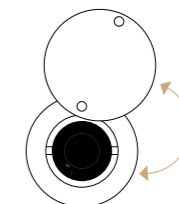

ARCHITECTURE HARDWARE ACCESSORIES / GENERAL HARDWARES

ARCHITECTURE HARDWARE ACCESSORIES / GENERAL HARDWARES



Letter Plate - outside



Letter Plate - inside

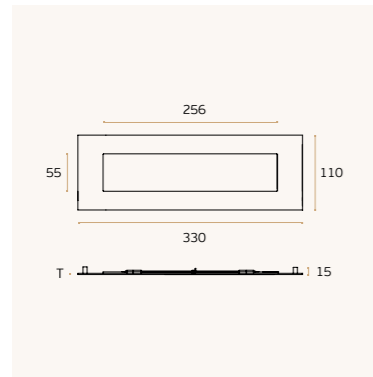

LP01-0

Material:SUS304 / SUS316
Available Finishes: SSS / PSS / AB / PC / PVD-SG/PG/SC/CRP/CRS

T
2
2.5

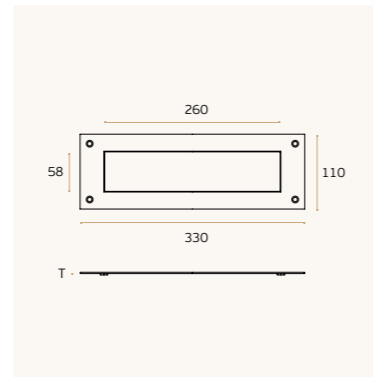

LP01-2

Material:SUS304 / SUS316
Available Finishes: SSS / PSS / AB / PC / PVD-SG/PG/SC/CRP/CRS

T
2
2.5



Dust Proof Socket

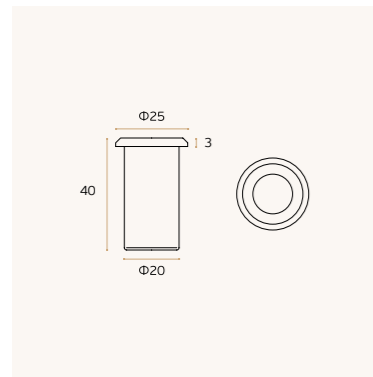

DPS-01

Material:SUS304 / SUS316
Available Finishes: SSS / PSS / AB / PC / PVD-SG/PG/SC/CRP/CRS



Handrail Bracket

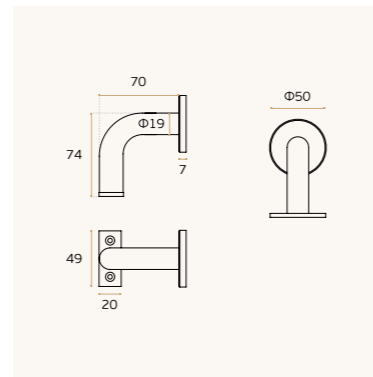

HB01

Material:SUS304 / SUS316
Available Finishes: SSS / PSS / AB / PC / PVD-SG/PG/SC/CRP/CRS

ARCHITECTURE HARDWARE ACCESSORIES / HOOKS

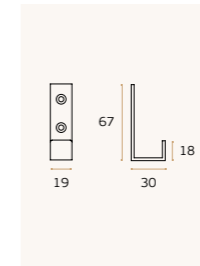

H01

Material:SUS304 / SUS316
Available Finishes: SSS / PSS / AB / PC / PVD-SG/PG/SC/CRP/CRS

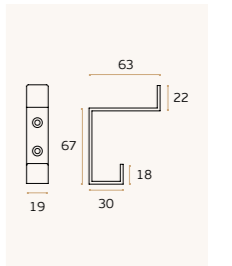

H02

Material:SUS304 / SUS316
Available Finishes: SSS / PSS / AB / PC / PVD-SG/PG/SC/CRP/CRS

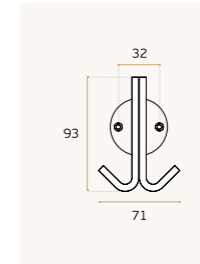

H03

Material:SUS304 / SUS316
Available Finishes: SSS / PSS / AB / PC / PVD-SG/PG/SC/CRP/CRS

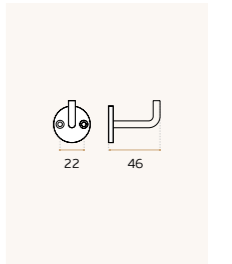

H04

Material:SUS304 / SUS316
Available Finishes: SSS / PSS / AB / PC / PVD-SG/PG/SC/CRP/CRS

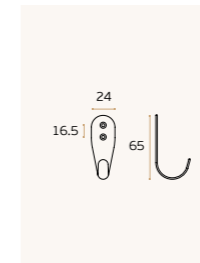

H05

Material:SUS304 / SUS316
Available Finishes: SSS / PSS / AB / PC / PVD-SG/PG/SC/CRP/CRS

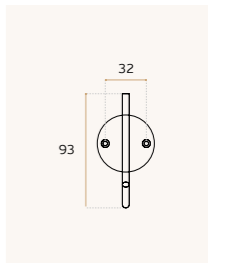

H06

Material:SUS304 / SUS316
Available Finishes: SSS / PSS / AB / PC / PVD-SG/PG/SC/CRP/CRS

www.hangfatmetal.com

JIANGMEN HANGFAT METAL PRODUCTS FACTORY

Address: Nacikeng Industrial District, Duruan Town,
Jiangmen City, Guangdong Province, China, 529075

Tel: +86 750 3663332 **Fax:** +86 750 3663442

E-mail: sales@hangfatmetal.com mulang@hangfatmetal.com

